



iron dog 01

State: 2024-05-16



BRUNNER[®]
made in germany.

Dimension sheets - iron dog 01

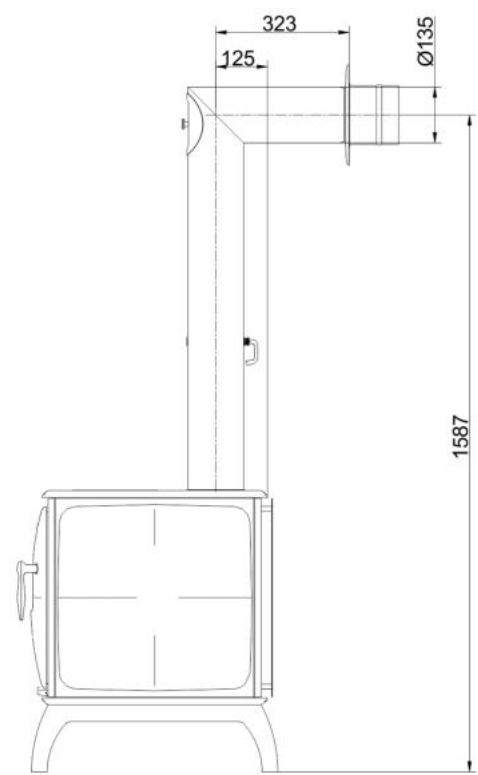
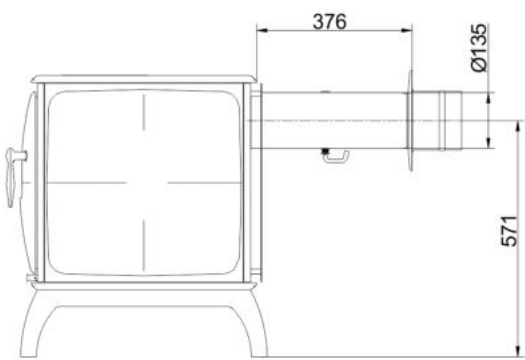
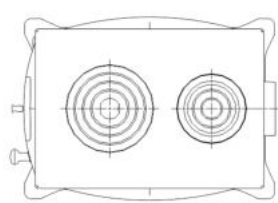
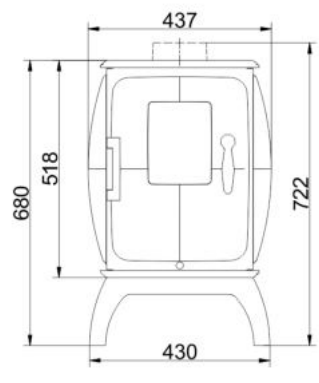
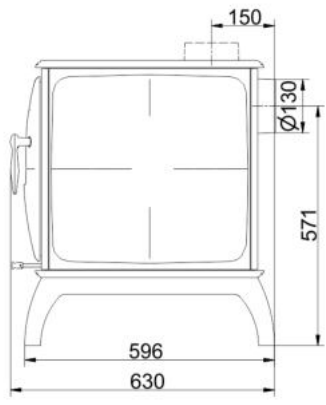

... with horizontal smoke pipe connection kit L form

Dimension sheets - iron dog 01

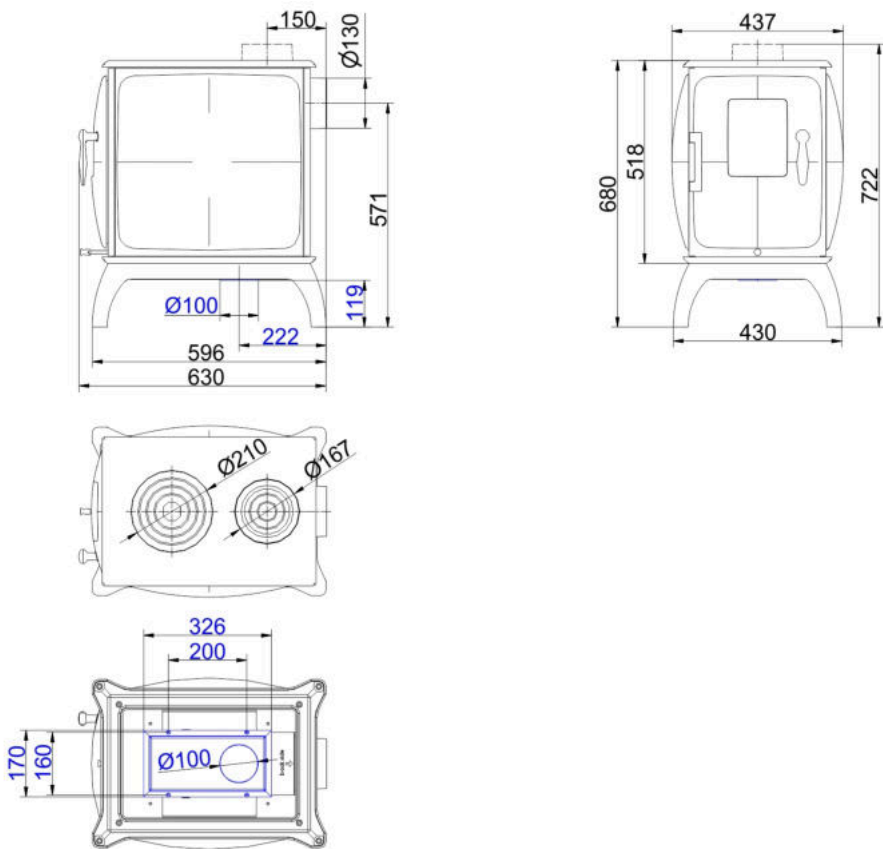

... with connection for combustion air

We suggest for CAD planning Palette CAD. Permanent updated drawings: www.brunner.de
Frames/ flue gas outlet connection/ combustion air supply connection/ front variants/ support bearing are marked in color.

Planning and installation - iron dog 01

Tested according to		EN 13240
Data for functional demonstration		
Rated heat power	kW	7
Fire wood volume	kg/h	2
Flue gas mass flow	g/s	7.6
Outlet temperature	°C	353
Necessary supply pressure	Pa	12
Combustion air consumption	m ³ /h	15
Flue gas pipe connection Ø	mm	130
Combustion air connection Ø	mm	100
Minimal distances ¹⁾		
to the side wall	cm	80
to the back wall	cm	40
to the back wall with stove- heat protective panel	cm	30
to the back wall with stove-and wall heat protective panel	cm	10
to the front	cm	80
Device data		
Dimensions (H x W x D)	mm	680 x 440 x 630
Combustion chamber opening	m ²	0.08
Combustion chamber depth	mm	400
Weight		
Total weight	kg	130
Meets requirement/limit values for:		
Germany/ Austria / Switzerland / Norway		1.BImSchV (Stufe 2) / 15a BVG (2015) / - / -

- 1) The specified safety distances ensure that no temperatures > 85°C are reached on adjacent components and walls. In the case of sensitive objects or furniture, maintain greater distances if necessary. For highly insulated walls (U-value < 0.4 W/m²K), the fire protection distance is increased by 5 cm to the corresponding side or rear wall.